

Reefs Price List

June 1, 2019

Contract #GS-27F-033CA

GSA MOD #PO-0024

Contract effective date:

September 21, 2015 - September 2025

DAUPHIN

Reefs

SIN: #33721

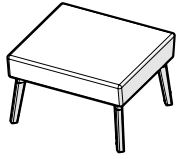

RF0601

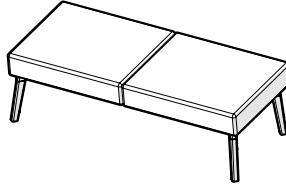

RF0602

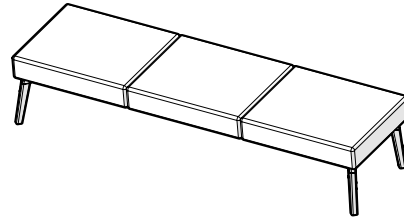

RF0603

Model #	Description	A/COM	B	C/COL	D	E	F	G	H	I	J/LTH
BENCHES											
RF0601	1 seat bench	\$1003	\$1037	\$1105	\$1173	\$1241	\$1309	\$1377	\$1445	\$1513	\$1581
RF0602	2 seat bench	\$1672	\$1740	\$1876	\$2012	\$2147	\$2283	\$2419	\$2555	\$2691	\$2827
RF0603	3 seat bench	\$2341	\$2443	\$2646	\$2850	\$3054	\$3258	\$3462	\$3665	\$3869	\$4073
RFBACK1	add-on price for single backrest	\$512	\$546	\$614	\$682	\$750	\$818	\$886	\$954	\$1021	\$1089

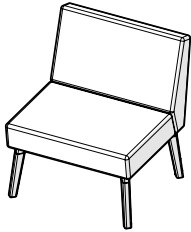

RF0611

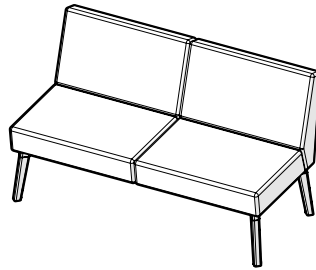

RF0612

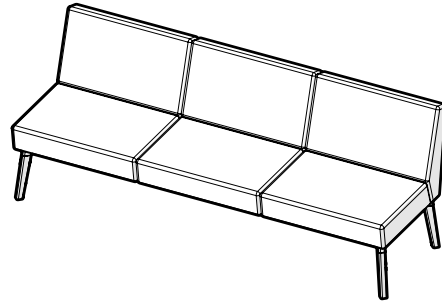

RF0613

BENCHES WITH BACKREST

RF0611	1 seat bench with backrest	\$1515	\$1583	\$1719	\$1855	\$1991	\$2127	\$2262	\$2398	\$2534	\$2670
RF0612	2 seat bench with backrest	\$2696	\$2832	\$3104	\$3375	\$3647	\$3919	\$4190	\$4462	\$4734	\$5006
RF0613	3 seat bench with backrest	\$3877	\$4081	\$4488	\$4896	\$5303	\$5711	\$6118	\$6526	\$6934	\$7341

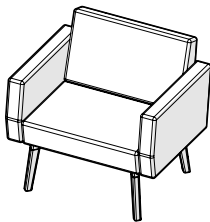

RF0641

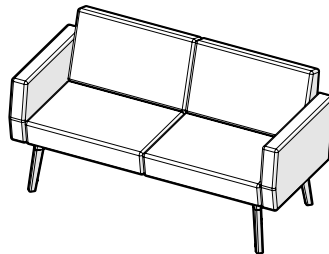

RF0642

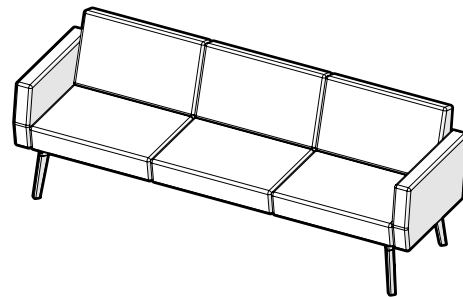

RF0643

SOFAS WITH ARMRESTS

RF0641	1 seat lounge chair with arms	\$2305	\$2399	\$2587	\$2776	\$2964	\$3152	\$3340	\$3528	\$3716	\$3904
RF0642	2 seat sofa with arms	\$3486	\$3648	\$3972	\$4296	\$4620	\$4620	\$5268	\$5592	\$5916	\$6240
RF0643	3 seat sofa with arms	\$4667	\$4897	\$5357	\$5816	\$6276	\$6736	\$7196	\$7656	\$8115	\$8575

Reefs

RF0691

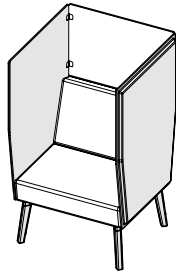

RF0692

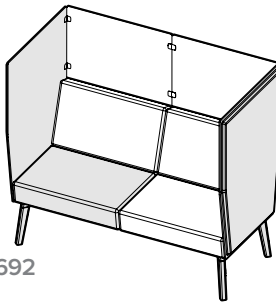

RF0693

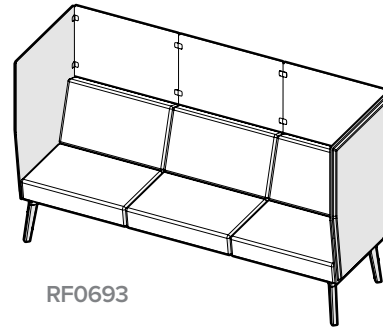

Model #	Description	A/COM	B	C/COL	D	E	F	G	H	I	J/LTH
SOFAS WITH PRIVACY SCREENS											
RF0691	1 seat lounge chair with privacy screens	\$3735	\$3803	\$3939	\$4075	\$4211	\$4347	\$4482	\$4618	\$4754	\$4890
RF0692	2 seat sofa with privacy screens	\$5656	\$5792	\$6064	\$6335	\$6607	\$6879	\$7150	\$7422	\$7694	\$7966
RF0693	3 seat sofa with privacy screens	\$7577	\$7781	\$8188	\$8596	\$9003	\$9411	\$9818	\$10,226	\$10,634	\$11,041

RF0694

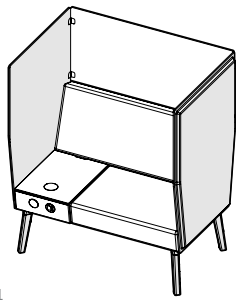

INDIVIDUAL WORK SOFA WITH PRIVACY SCREENS

RF0694	Individual work lounge chair with side table & privacy screens	\$3735	\$3803	\$3939	\$4075	\$4211	\$4347	\$4482	\$4618	\$4754	\$4890
--------	--	--------	--------	--------	--------	--------	--------	--------	--------	--------	--------

STANDARD SPECIFICATIONS

Chair construction

Foam over CARB compliant plywood frame, with aluminum seat support structure

Upholstery

Seat and backrest cushions are fixed and can be upholstered in different fabrics

Privacy screens

Polyester fiber fleece over 100% recycled paperboard composite; total height 52" from floor

Feet

Black aluminum

Glides

Nylon glides for carpet surface

OPTIONAL SPECIFICATIONS

Power & Data

See separate Power & Data price list, p. 13 of 2/19 price book

Feet

Natural oak - special order. Check lead time with Customer Service **\$84**

Hard floor glides

Glides with soft surface for hard floor **\$21**

COM/COL	COM	COL	DIMENSIONS (IN INCHES)			
			Width	Seat Depth	Overall Depth	Height from Floor
1 seat bench	1.50	27	28	26	26	17.5
2 seat bench	3.00	54	56	26	26	17.5
3 seat bench	4.50	81	84	26	26	17.5
1 seat bench with backrest	3.00	54	28	19.5	26	32.5
2 seat bench with backrest	6.00	108	56	19.5	26	32.5
3 seat bench with backrest	9.00	162	84	19.5	26	32.5
1 seat lounge chair with arms	4.50	81	36	19.5	26	32.5
2 seat sofa with arms	7.50	135	64	19.5	26	32.5
3 seat sofa with arms	10.50	189	92	19.5	26	32.5
1 seat lounge chair with privacy screens	3.00	54	31	19.5	27	52
2 seat sofa with privacy screens	6.00	108	59	19.5	27	52
3 seat sofa with privacy screens	9.00	162	87	19.5	27	52
Individual work sofa with privacy screens	4.50	81	45	19.5	27	52

September 5, 2019

DAUPHIN

Reefs

SIN: #33721

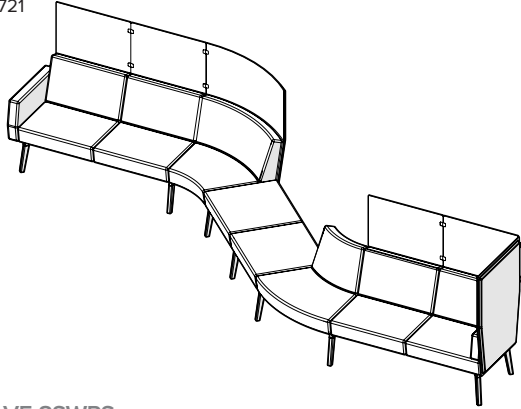

RFWAVE-8SWPS

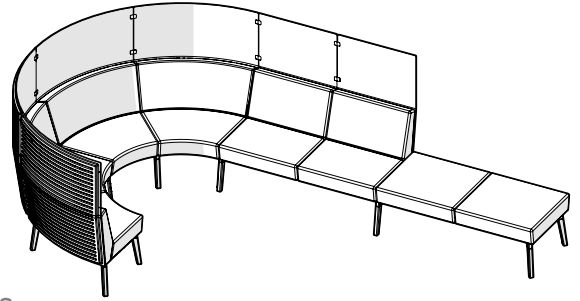

RFSNAIL-8SWPS

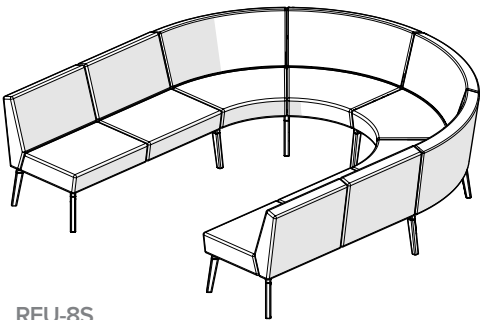

RFU-8S

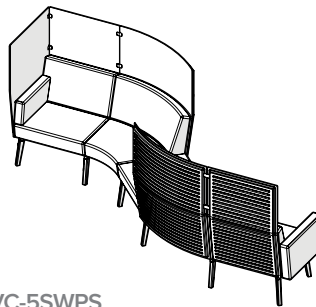

RFVAVC-5SWPS

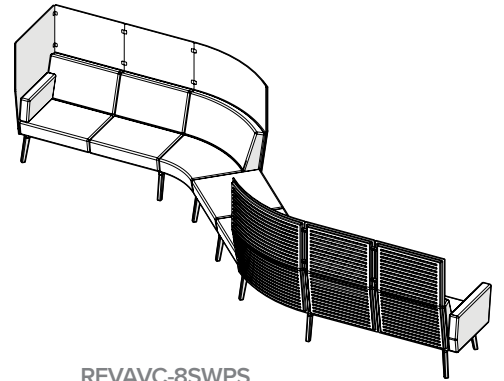

RFVAVC-8SWPS

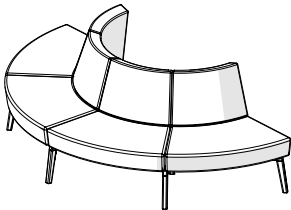

RFHM-4S

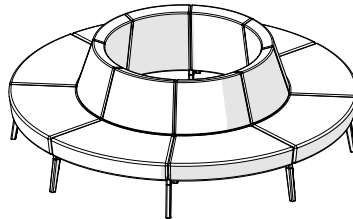

RFFCO-8S

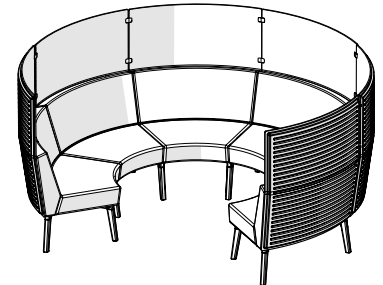

RFTQCI-6SWPS

Model #	Description	A/COM	B	C/COL	D	E	F	G	H	I	J/LTH
CONNECT CONFIGURATIONS											
RFFTFL-4S	FACE TO FACE LOUNGE, two 2-seat sofas with arms. Not shown.	\$6972									
RFWAVE-8SWPS	WAVE, 8 seats with privacy screens	\$14,364									
RFSNAIL-8SWPS	SNAIL, 8 seats with privacy screens	\$17,446									
RFU-8S	U SHAPE, 8 seats	\$00,000									
RFVAVC-5SWPS	VIS-A-VIS, 5 seats with privacy screens	\$11,879									
RFVAVC-8SWPS	VIS-A-VIS, 8 seats with privacy screens	\$15,683									
RFHM-4S	HALF MOON, 4 seats	\$00,000									
RFFCO-8S	FULL CIRCLE OUTWARDS, 8 seats	\$00,000									
RFTQCI-6SWPS	3/4 CIRCLE INWARDS, 6 seat huddle with privacy screens	\$17,697									